

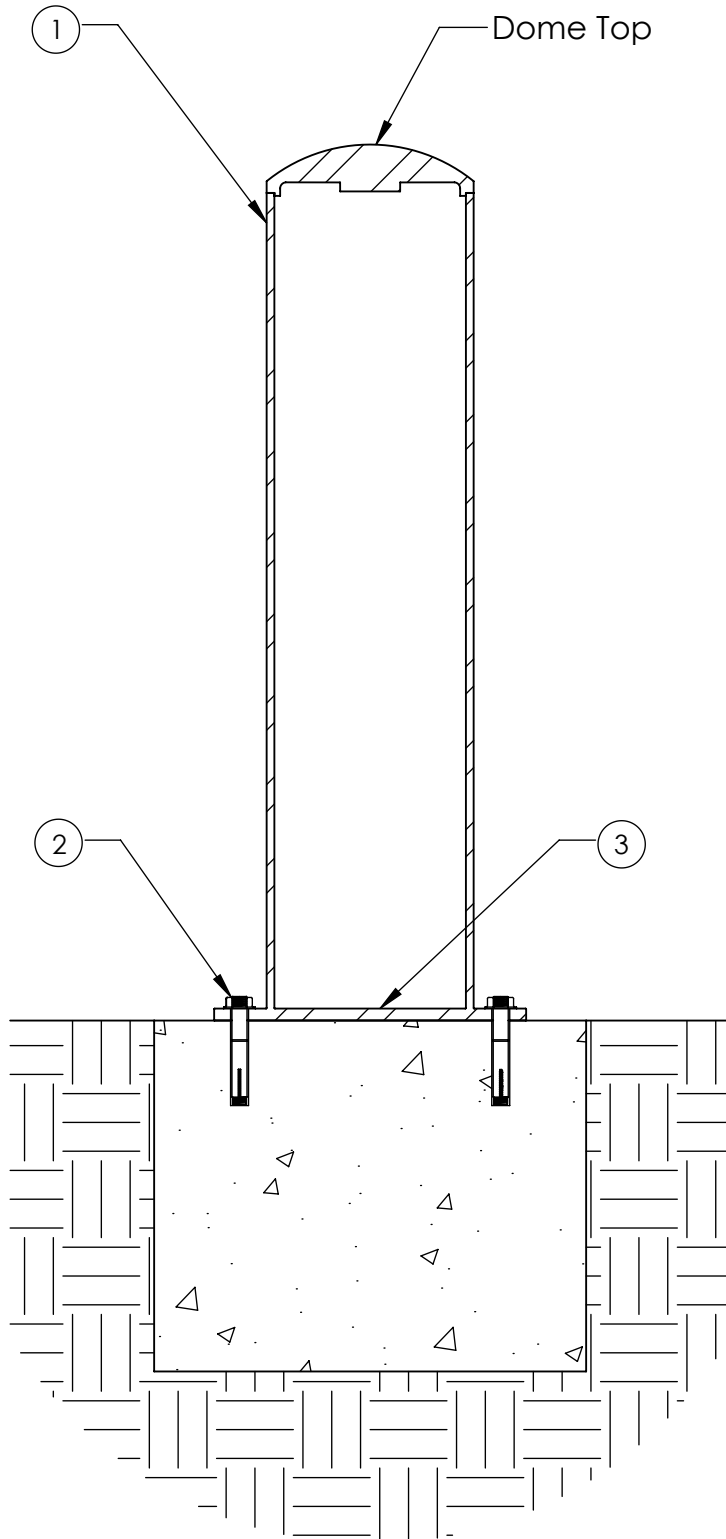

# Type B - Bolt Mount

Series: Derby

Product Number: 380-SD



## 36" TALL S.S. BOLLARD SLEEVE

ITEM	QTY	PART	WEIGHT
1	1	8" Dome top Schedule 40 steel bollard cover.	91.2 lbs.
2	4	5/8" x 4" Stainless steel anchor bolts.	3 lbs.
3	1	13" dia. x 1/2" Stainless steel base plate, 5/8" holes (4)	18.7 lbs.

-Stainless steel bollard mounts to concrete by (4) 5/8" x 4" anchor bolts.

-Footer detail is for reference only; proper footer construction depends on local soil conditions and engineering requirements.