

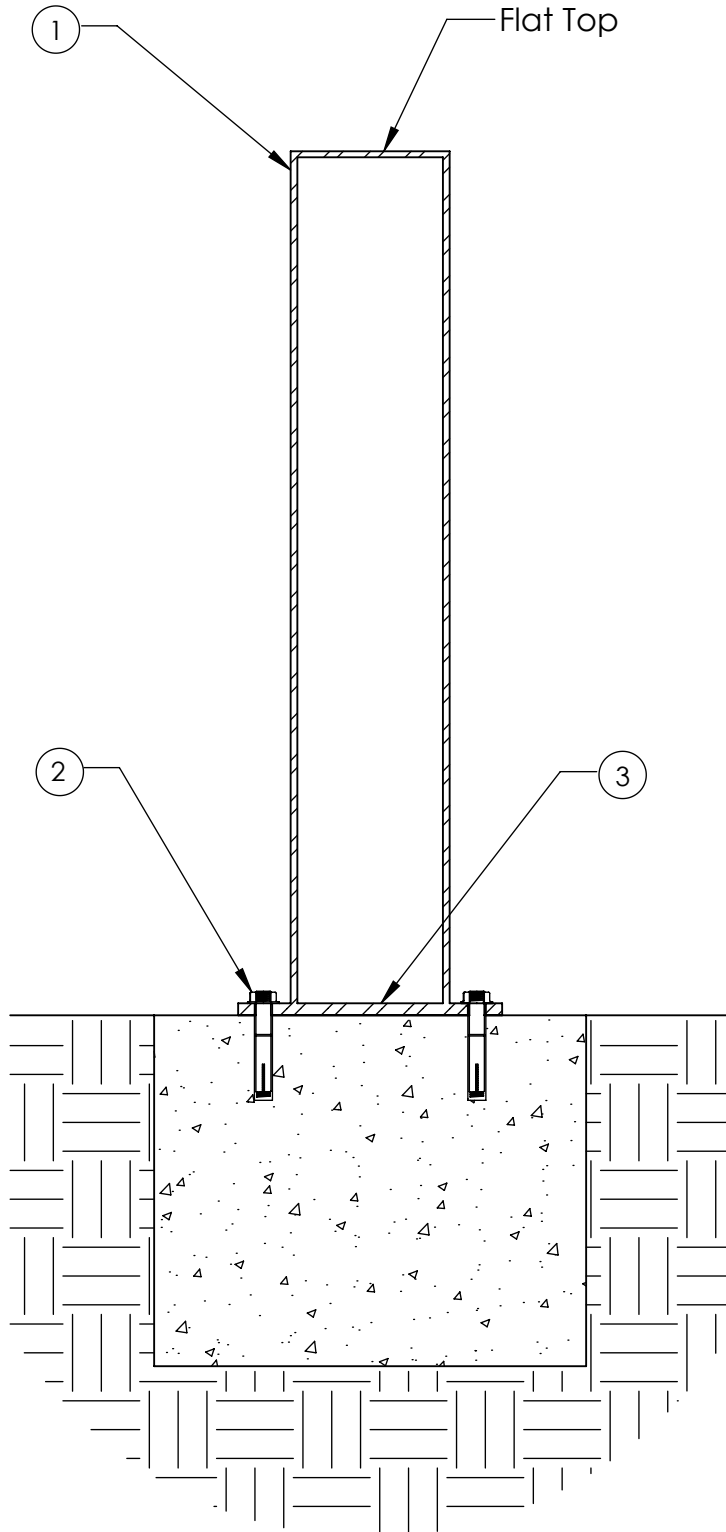

Type B - Bolt Mount

Series: Bastion

Product Number: 360-SF



36" TALL M.S. BOLLARD SLEEVE

ITEM	QTY	PART	WEIGHT
1	1	6" Flat top Schedule 40 mild steel bollard cover.	59.6 lbs.
2	4	5/8" x 4" Stainless steel anchor bolts.	3 lbs.
3	1	11" dia. x 1/2" Stainless steel base plate, 5/8" holes (4)	13.3 lbs.

-Mild steel bollard mounts to concrete by (4) 5/8" x 4" anchor bolts.

-Footer detail is for reference only; proper footer construction depends on local soil conditions and engineering requirements.