

# Type R2 - Padlock

Series: 150 Century

Product Number: 150-QT

| ITEM | QTY | PART                             | WEIGHT     |
|------|-----|----------------------------------|------------|
| 1    | 2   | 3/8" Plastic screw caps.         | .18 g. ea. |
| 2    | 2   | 1" Plastic bar hole caps.        | 5 g. ea.   |
| 3    | 1   | 150 Cast Iron plain body.        | 51.6 lbs.  |
| 4    | 1   | 150 Cast Iron step base.         | 32.3 lbs.  |
| 5    | 1   | 150 Cast Iron R-2 insert.        | 47.2 lbs.  |
| 6    | 1   | 6" Cast Iron Queen top.          | 23.2 lbs.  |
| 7    | 2   | 3/8" Stainless steel set screws. | 2.7 g. ea. |
| 8    | 1   | 150 Steel locking pipe for R-2   | 16.5 lbs.  |
| 9    | 1   | Plastic padlock cover            | 82 g.      |
| 10   | 1   | Steel padlock                    | .3 lbs.    |
| 11   | 1   | Threaded eyebolt                 | 27 g.      |
| 12   | 1   | 30" Steel Install/Removal Bar.   | 3.8 lbs.   |
| 13   | 1   | Removable steel plug.            | 9.25 lbs.  |

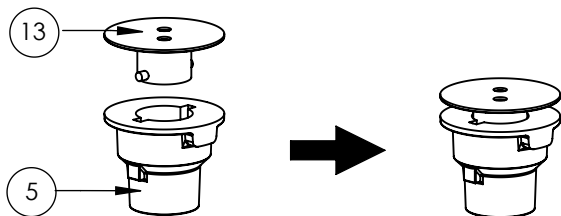
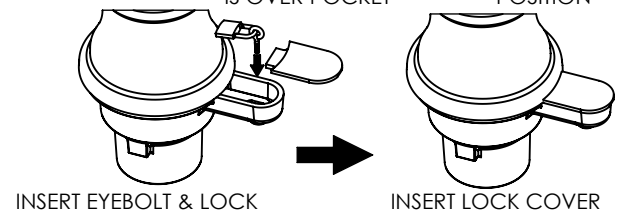
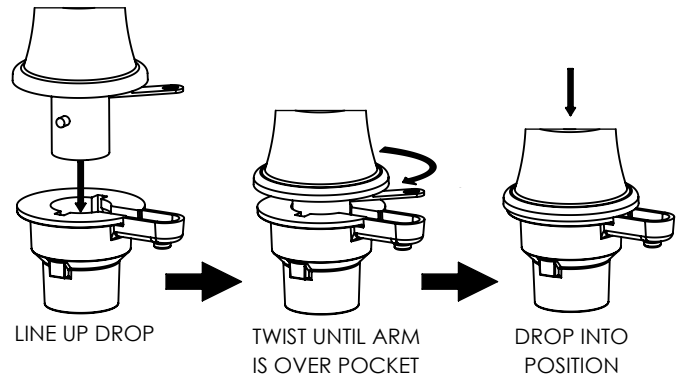
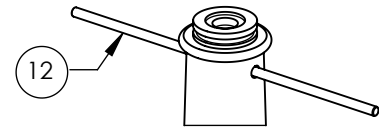
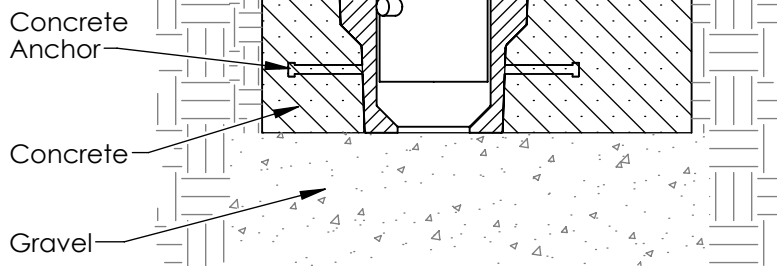
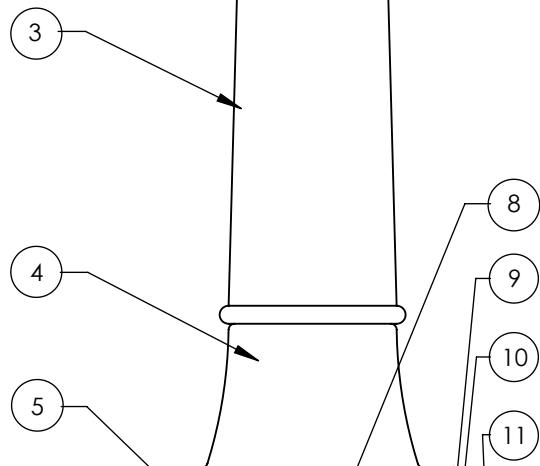
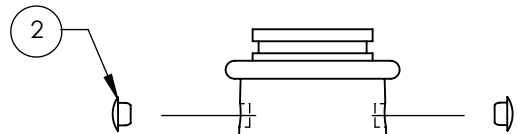
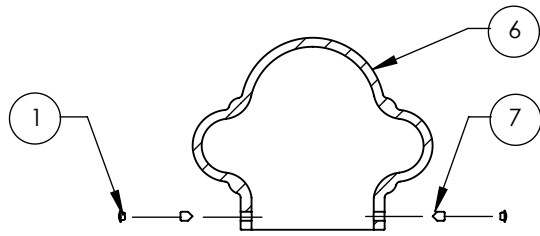

INSTALLATION OF STEEL COVER

-Slide installation bar through openings in top of bollard, lower bollard into Twist&Lock insert seated on top of gravel for drainage, rotate bollard clockwise until it drops into place with locking pipe slotted arm seated in iron insert. Use eyebolt with padlock to secure bollard in place, use set screws to secure Queen top.

-Footer detail is for reference only; proper footer construction depends on local soil conditions and engineering requirements.